

1  
APR 30 1946  
Alpha File

# I-B-R INSTALLATION GUIDE Number 2

## One Pipe Steam Heating Systems

•  
For buildings having a heat loss  
not exceeding 92,640 Btu per hour  
(Equal to 386 sq. ft. of Steam Radiation)

•  
March, 1946



Reg. U. S. Pat. Off.

796

THE INSTITUTE OF BOILER AND RADIATOR MANUFACTURERS  
60 East 42nd Street  
New York 17, N. Y.

Price 25 cents

The Institute of Boiler and Radiator Manufacturers is indebted to the Heating, Piping and Air Conditioning Contractors National Association for their assistance in preparing this Installation Guide.



Reg. U. S. Pat. Off.

COPYRIGHT, 1946, BY  
THE INSTITUTE OF BOILER AND RADIATOR MANUFACTURERS

Text and illustrations are fully protected by copyright and nothing that appears may be reprinted either wholly or in part without special permission.

## PREFACE

**T**HIS I=B=R INSTALLATION GUIDE NO. 2 is the second in a series published by The Institute of Boiler and Radiator Manufacturers. It provides the basis for installing one-pipe steam heating systems for buildings having a heat loss not exceeding 92,640 Btu per hour, equal to 386 sq. ft. of steam radiation, which is the maximum capacity for a 2" main. I=B=R Installation Guide No. 1, published in January 1945, covers the installation of one-pipe forced circulation hot water heating systems.

The contents of this Guide No. 2 are based on the best information available for a one-pipe steam system. The members of The Institute of Boiler and Radiator Manufacturers for several years have carried out a research program in collaboration with the University of Illinois and further research work on this type of system is under way.

The enthusiastic response which followed the publication of I=B=R Installation Guide No. 1 confirms the opinion held by the members of the Institute that these I=B=R Guides will contribute in large measure to an expanding use of steam and hot water heating systems. Their function is to provide a simple, efficient and economical basis for calculating and designing such systems.

For this steam system **THREE SIMPLE STEPS** are provided on page 5. Once the measurements of the house are known, there are no further calculations. Merely read the answers from the tables.

Calculation sheets for use in calculating and designing jobs based on I=B=R Installation Guides Nos. 1 and 2 are available from any of the manufacturers listed on the back cover.

Additional copies of these Guides may  
be obtained at 25 cents per copy from

**THE INSTITUTE OF BOILER AND RADIATOR MANUFACTURERS**  
60 East 42nd Street • New York 17, N. Y.



Reg. U. S. Pat. Off.

COPYRIGHT 1946, BY  
THE INSTITUTE OF BOILER AND RADIATOR MANUFACTURERS

## RECOMMENDED INSTALLATION PRACTICE

### General

All pipes shall be reamed. Risers in uninsulated exposed walls and piping in unheated portions of the basement should be insulated.

### Controls

In addition to the safety and thermostatic controls regularly furnished with the boiler, additional controls, such as water feeders and low water cutoffs, may be installed in accordance with the control manufacturer's recommendations.

### Cleaning

All oil and grease must be removed from the interior of the boiler and piping. Drawing water from the bottom of the boiler will not clean it as the grease and oil will adhere to the boiler sides. Follow the boiler manufacturer's directions for cleaning the system.

### Main

The size of the steam main shall be 2". The main riser from the boiler to the horizontal main shall be full size of the boiler tapping. If the boiler tapping is larger than the horizontal main a reducing elbow should be used at the top of the main riser. See Fig. 1.

The distance between the water line in the boiler and the low point of the main should be not less than 18". See Fig. 2.

A reduction in vertical main size should be made with a reducing fitting placed below the water line. See Fig. 2.

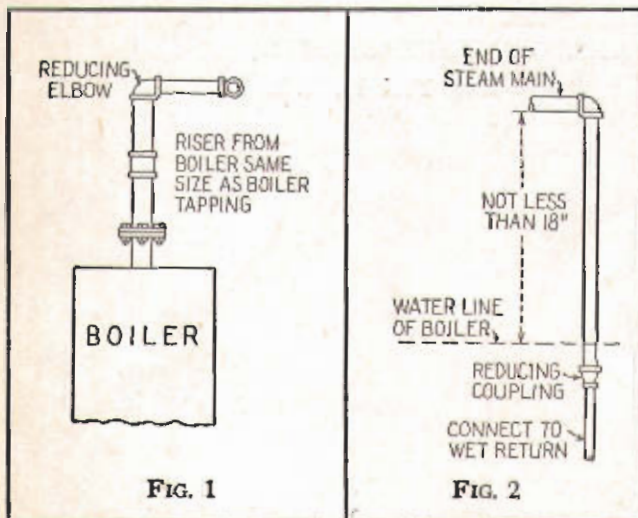

### Expansion of Piping

Swing joints should be provided on the main at the boiler and on runouts to stubs and risers. See Fig. 3.

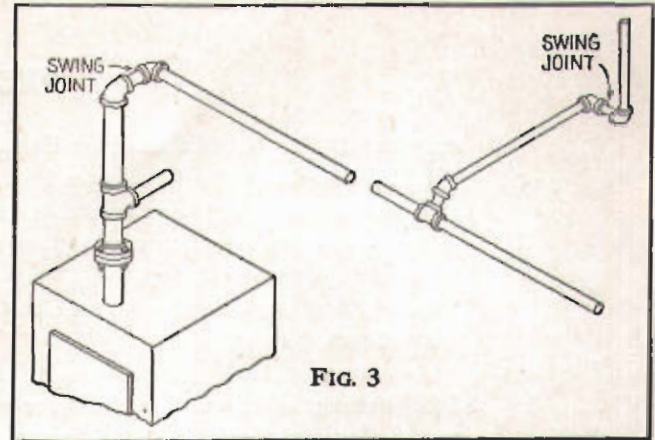

FIG. 3

### Pitch of Pipes

The pipes shall pitch not less than  $\frac{1}{4}$ " in ten feet where the condensation is flowing in the same direction as the steam, and not less than  $\frac{1}{2}$ " in ten feet where the condensation is flowing opposite to the flow of steam. See Fig. 4.

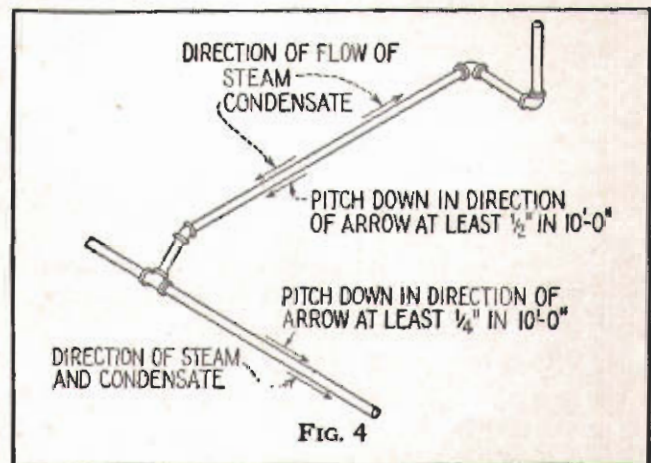

FIG. 4

### Double Circuit

Where a trunk divides into two circuits a tee and an ell must be used. See Fig. 5.

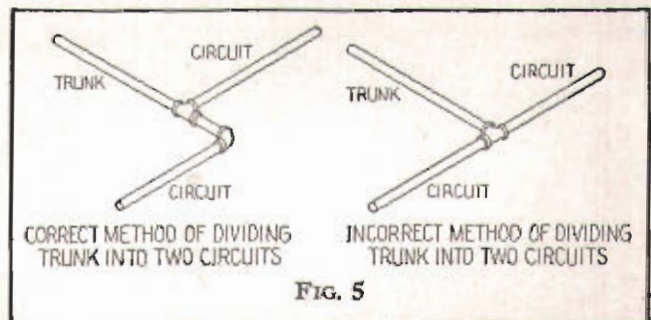

FIG. 5

### Unit Heaters

The bottom of a Unit Heater should be not less than 24" above the water line of the boiler. The return should be connected through a 15° check valve to a wet return as far below the Unit Heater as possible.

The air vent should be piped from the return to a point above the Unit Heater. See Fig. 6.

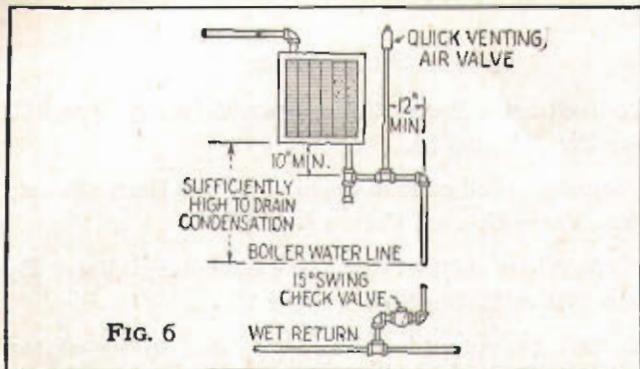

FIG. 6

### Venting

Radiators and ends of mains should be vented. *Without proper venting satisfactory operation cannot be obtained.* Therefore a good quality air valve should be used.

Mains should be individually vented and tied together only below the water line. A main vent valve should have a large venting capacity and should be placed as high above the main as possible and not less than 15" from the point where the main drops to the boiler or wet return. See Fig. 7.

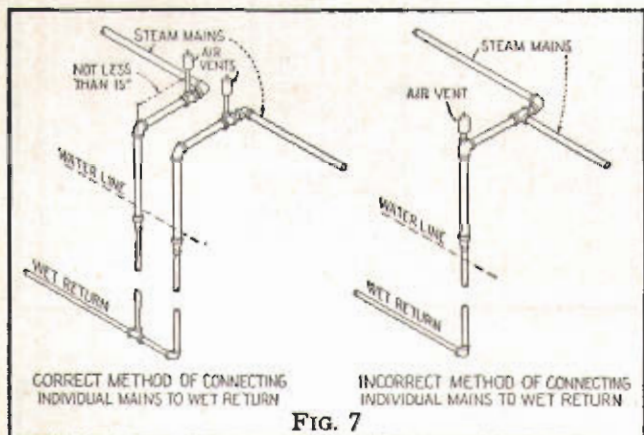

FIG. 7

Air valves should be placed on radiators as shown in Fig. 8. Adjustable radiator air valves are recommended for automatically fired systems.

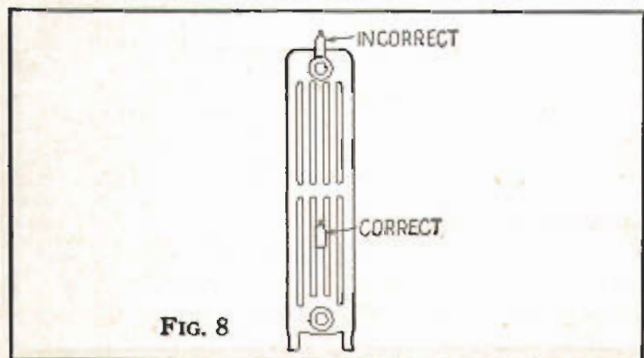

FIG. 8

There are two basic types of one-pipe steam systems, the non-vacuum and the vacuum system.

In the non-vacuum system, using non-vacuum venting valves, as soon as the water is heated to the point where it forms steam the pressure caused by the steam forces the air out of the system through the venting valves. The rate at which the air is expelled may be controlled by the use and proper adjustment of variable venting valves. By this means the distribution of steam in the system may be controlled so that all radiators will heat more uniformly.

In the vacuum system, using vacuum venting valves, and assuming that no vacuum exists in the system at the beginning of the firing cycle, these valves function exactly the same as the above mentioned non-vacuum valves. As cooling takes place, the vacuum valves prevent the intake of air into the system and a partial vacuum is created, which causes a continued heat transfer by steam from the boiler to the radiators. To insure the proper operation of vacuum valves on this system, when automatically fired, it is necessary to provide some means for breaking the vacuum in the system prior to or at the time of the start of the firing cycle.

### Hartford Loop

A Hartford Loop should be used to connect the return to the boiler as a safety measure to prevent the boiler from losing its water through the return. The steam equalizing pipe should be not less than 1½". See Figs. 9 and 10.

Where a valve is used in the supply riser from the boiler, as is required in some sections of the country for pressure testing the boiler after erection, it should be placed above the connection to the Hartford Loop. See dotted valves in supply and return connections in Figs. 9 and 10.

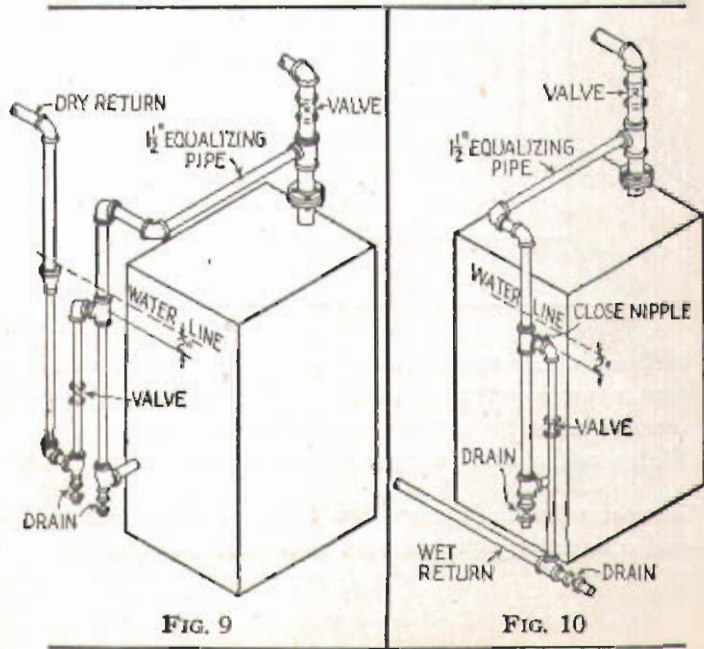

FIG. 9

FIG. 10

## Domestic Hot Water

If an external water heater is used it should be piped to the boiler below the water line. See Fig. 11.

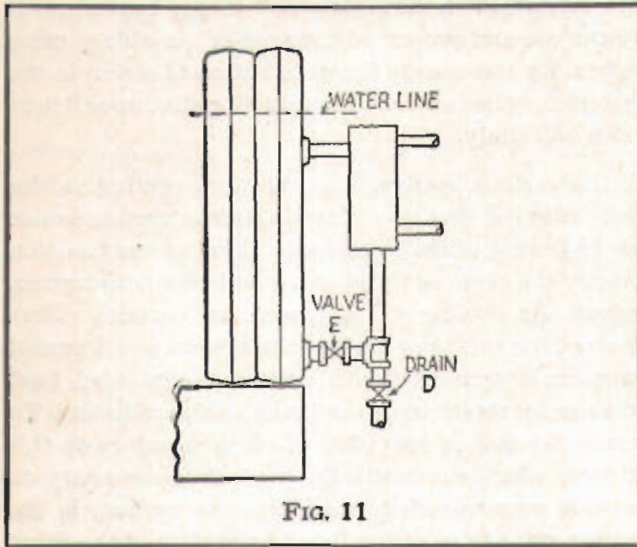

FIG. 11

In boilers having a water line below the top nipple port, all sections should be tapped as high as possible below the water line and connected to the heater by a header if domestic water is to be supplied in the summer. See Fig. 12.

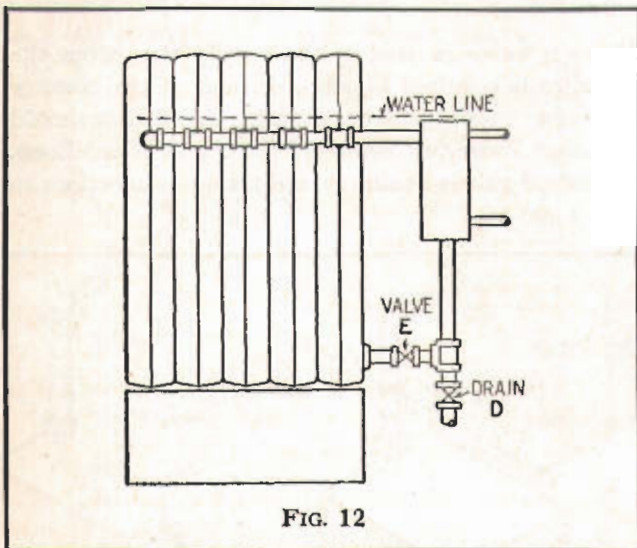

FIG. 12

Indirect water heaters used to supply summer and winter hot water must be of a larger capacity than those required for winter use only, because the average winter boiler water temperature is higher.

The range boiler (storage tank), indirect water heater and connecting piping should be insulated in order to

provide fuel economy, lower summer house temperature and reduced boiler tax.

## Range Boiler

To flush out a Range Boiler open Valves A, B and C. See Figs. 13 and 14.

To flush out coil of heater connected to a Range Boiler, close Valve C; open Valves A and B.

To flush out shell of external heater; open Valve D; close Valve E. See Figs. 11 and 12.

To throttle output of external heater during winter weather, partially close Valve E. See Figs. 11 and 12.

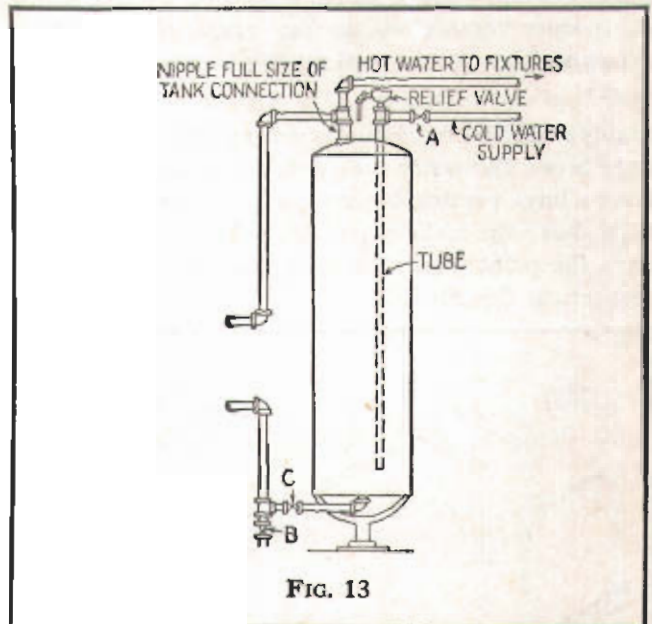

FIG. 13

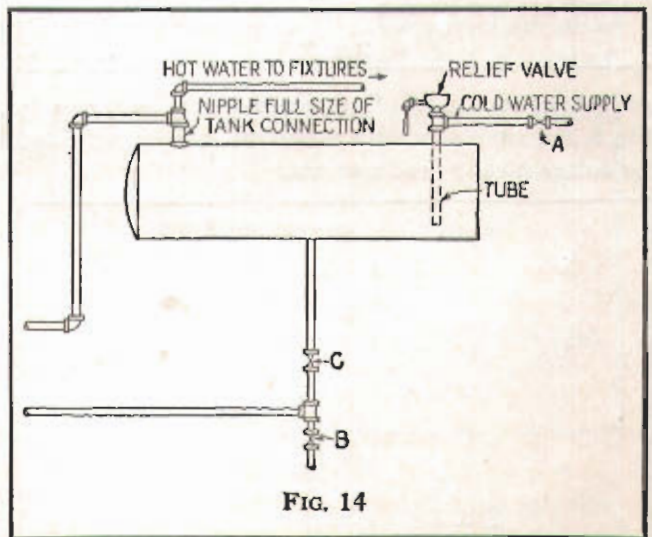

FIG. 14

# CALCULATION AND DESIGN

## Procedure

- STEP 1.** Determine the radiation (Tables 1, 2 and 3, pages 8-12)
- STEP 2.** Select the size of piping (Table 4, page 13)
- STEP 3.** Select the boiler

### Examples of Procedure

The example which follows each of the Steps refers to a two-story frame house shown in Figures A and B, with 220.8 sq. ft. of installed radiation supplied by 11 radiators and a main divided into two circuits. All data concerning the calculation of the system appear in the calculation sheet down on page 6.

On pages 13 and 14 are plans and calculation sheet for a one-story frame house and single circuit main.

**STEP 1:** Determine the radiation required for each room to be heated, using Tables 1, 2 and 3, pages 8 to 12. (Heat loss may also be calculated by using the American Society of Heating and Ventilating Engineers Guide or the Engineering Standards of the Heating, Piping and Air Conditioning Contractors National Association.)

*Example:* Given a room (see bedroom No. 1) 15' x 13' x 7'4", having one long and one short wall exposed, three single weatherstripped windows 3' x 4'3". Cold attic above. 3 3/8" rock wool in wall and ceiling. Temperature difference 70 F indoors, -10 F outdoors = 80 F.

## CONSTRUCTION

CALCULATION OF QUANTITIES		FROM TABLE 1		FROM TABLE 2	
		Type of Construction and Factors		Radiation Required*	
		Item	Factor		
		Col. A	Col. B	Col. C	Col. D
Gross Wall.....	$(15' + 13') \times 7'4" =$	205.3 sq. ft.			
Window.....	$(3' \times 4'3") \times 3 =$	38.3 sq. ft.	18a (pg. 9)	1.13	12.5
Net Wall.....	205.3 - 38.3 =	167.0 sq. ft.	2c (pg. 8)	0.08	4.0
Ceiling.....	$15' \times 13' =$	195.0 sq. ft.	12f (pg. 9)	0.08	4.5
Infiltration (Room Volume).....	$15' \times 13' \times 7'4" =$	1,430.0 cu. ft.	20b (pg. 9)	0.017	7.0

Total for 70 F Indoor - Outdoor Temperature Difference 28.0

For an 80 F temperature difference refer to Table 3, page 12. In the column headed 70 F move down to 28.0, then horizontally to the column headed 80 F and read the radiation required as 32.0 square feet.

\*Radiation is obtained as follows:

1. Find factor at the top of Table 2 corresponding to factor in Col. C above.
2. Read down under that factor in Table 2 to the figure nearest the quantity shown in Col. A above.
3. Read to the left for the Radiation required.

### STEP 2: Select the size of piping using Table 4, page 13.

*Example:* Given a house with 220.8 sq. ft. of installed radiation served by 11 radiators.

As a double circuit main will deliver steam to all radiators more quickly and uniformly, the piping for this example has been designed for a two circuit system.

According to Table 4, the main size should be 2", which should not be reduced before dropping below the water line. The risers, runouts and valve sizes should be 1" for radiators of 28 sq. ft. and less, and 1 1/4" for those from 28 sq. ft. to 62 sq. ft.

**STEP 3:** From manufacturer's catalog, select boiler having a net I=B=R Rating in square feet of steam radiation equal to or greater than the total calculated under Step 1. Allowance for domestic hot water need only be made in the selection of a boiler if there are more than two bathrooms to be served

or if the use of domestic hot water exceeds 75 gallons in twenty-four hours, in which cases the following allowances should be made:

**STORAGE TYPE HEATER:** One-half square foot of steam radiation per gallon of storage tank capacity.

**TANKLESS HEATER:** Fifty square feet of steam radiation for each bathroom in excess of two.

*Note:* Since the publication of I=B=R Installation Guide No. 1 research work conducted at the I=B=R Research Home has proven that the allowances for domestic hot water contained herein are adequate both for steam and hot water heating systems.

*Example:* The house used as an example in this Guide has one bathroom and requires 220.8 sq. ft. of installed steam radiation. A boiler with a net I=B=R Rating equal to or in excess of 220.8 sq. ft. of installed steam radiation should be used.

CALCULATION SHEET

ONE PIPE STEAM SYSTEM

Owner \_\_\_\_\_ Kind of building Residence (Two Story) Date \_\_\_\_\_  
 Architect \_\_\_\_\_ Type wall construction Frame-3 5/8" Rockwool Chimney height 35'  
 Address \_\_\_\_\_ Type windows Single-Weatherstripped Basement height 7'-2"  
 Dealer \_\_\_\_\_ Type roof or ceiling 3 5/8" Rockwool Temperature difference 80 F.  
 Address \_\_\_\_\_

Room	Length	Width	Height	Area, square feet				Volume cu. ft.	Radiation		Radiator size				Runout, riser & valve size
				Glass	Wall	Ceiling	Floor		Sq. ft. at 70 F. td.	Sq. ft. at 80 F. td.	sections	Height	Tube	Footage	
				1.13	0.08	0.08			0.017	0.011					
Living Room	18 <sup>4</sup>	15	7 <sup>8</sup>	*45 † 15.0	210 5.0			2110 10.5	30.5	34.8	10 10	22 22	4 4	18.0 18.0	1 1
Dining Room	13	12	✓	77.3 25.5	115 2.5			1195 6.0	34.0	38.8	20	25	4	40.0	1/4
Kitchen	13	9	✓	28.2 9.5	73 1.5			970 5.0	16.0	18.2	10	22	4	18.0	1
Lavatory	8	3	✓	8.75 3.0	75 1.5			184 0.5	5.0	5.7	4	25	3	6.4	1
Hall-1st. Fl.	15	7	✓	20 6.5	112 2.5			805 6.5	26.0	29.6	16	25	4	32.0	1/4
Hall-2nd. Fl.	14 <sup>6</sup>	8	7 <sup>4</sup>	12.8 4.0	90 2.0	96 2.0		705 2.5							
Bed Rm. #1	15	13	7 <sup>4</sup>	38.3 12.5	167 4.0	195 4.5		1430 7.0	28.0	32.0	18	22	4	32.4	1/4
Bed Rm. #2	14 <sup>8</sup>	10 <sup>8</sup>	✓	25.6 8.5	167 4.0	156 3.5		1145 5.5	21.5	24.5	14	22	4	25.2	1
Bed Rm. #3	11	11	✓	25.6 8.5	77 2.0	121 3.0		890 3.0	16.5	18.8	10	22	4	18.0	1
Bath	8	6 <sup>8</sup>	✓	12.8 4.0	96 2.0	54 1.0		396 2.0	9.0	10.3	8	25	3	12.8	1
Totals									214.7					220.8	

Form 2001-46 for I=B=R Installation Guide No. 2.

\* This is the area in square feet.  
 † This is the square feet of radiation from Table 2.

NOTE—Blank copies of this form may be obtained from any of the manufacturers listed on the back cover.





TABLE 1  
HEAT LOSS FACTORS

ITEM	DESCRIPTION	FACTOR	ITEM	DESCRIPTION	FACTOR
<b>WALLS</b>			<b>WALLS (Cont.)</b>		
<b>No. 1. Exposed Walls, Frame, Not Insulated</b>			<b>No. 6. Exposed Walls, Cinder Block</b>		
(a)	Clapboards or wood siding, studs, lath and plaster (no sheathing).....	0.35	(a)	8" Cinder block, plain.....	0.42
(b)	Same as (1a) with composition siding over wood siding.....	0.28	(b)	Same as (6a) plastered one side.....	0.39
(c)	Wood siding, paper, sheathing, studs, lath and plaster.....	0.25	(c)	Same as (6a) furred, lath and plaster.....	0.27
(d)	Same as (1c) with composition siding over wood siding.....	0.21	(d)	Same as (6c) substituting 1/2" rigid insulation for lath.....	0.20
(e)	Same as (1c) substituting asphalt or asbestos shingles for wood siding.....	0.30	<b>No. 7. Exposed Walls, Concrete Block</b>		
<b>No. 2. Exposed Walls, Frame, Insulated</b>			(a)	8" Concrete block, plain, above grade.....	0.56
(a)	Wood siding, paper, sheathing, studs, 1/2" rigid insulation, plaster.....	0.19	(b)	Same as (7a) plastered one side.....	0.51
(b)	Wood siding, 25/32" rigid insulation, studs, lath and plaster.....	0.19	(c)	Same as (7a) furred, lath and plaster.....	0.32
(c)	Wood siding, paper, sheathing, 1/2" flexible insulation in contact with sheathing, studs, lath and plaster.....	0.17	(d)	Same as (7a) substituting 1/2" rigid insulation for lath.....	0.23
(d)	Same as (2c) with air space on both sides of insulation.....	0.15	(e)	Same as (7a) basement wall below grade.....	0.06
(e)	Same as (2c) substituting 3 5/8" rockwool or equivalent for the 1/2" flexible insulation.....	0.08	(f)	12" Concrete block, plain, above grade.....	0.49
<b>No. 3. Exposed Walls, Brick, Not Insulated</b>			(g)	Same as (7f) basement wall below grade.....	0.06
(a)	8" brick, plastered one side.....	0.46	<b>No. 8. Exposed Walls, Poured Concrete</b>		
(b)	8" brick, furred, lath and plaster one side.....	0.30	(a)	8" Concrete wall, above grade.....	0.69
(c)	12" brick, plastered one side.....	0.34	(b)	8" Concrete wall, below grade.....	0.06
(d)	12" brick, furred, lath and plaster one side.....	0.24	(c)	12" Concrete wall, above grade.....	0.56
(e)	4" brick, 8" hollow tile, plastered one side.....	0.33	(d)	12" Concrete wall, below grade.....	0.06
(f)	Same as (3e) furred, lath and plaster.....	0.24	<b>No. 9. Exposed Walls, Limestone or Sandstone</b>		
(g)	4" brick, paper, wood sheathing, studs, lath and plaster.....	0.27	(a)	8" Stone, furred, lath and plaster.....	0.37
<b>No. 4. Exposed Walls, Brick, Insulated</b>			(b)	Same as (9a) substituting 1/2" rigid insulation for lath.....	0.25
(a)	8" brick, furred, 1/2" rigid insulation, plaster one side.....	0.22	(c)	12" Stone, furred, lath and plaster.....	0.33
(b)	12" brick, furred, 1/2" rigid insulation, plaster one side.....	0.19	(d)	Same as (9c) substituting 1/2" rigid insulation for lath.....	0.23
(c)	4" brick, 8" hollow tile, 1/2" rigid insulation, plaster one side.....	0.18	(e)	12" Stone below grade.....	0.06
(d)	4" brick, paper, wood sheathing, studs, rigid insulation, plaster.....	0.20	(f)	16" Stone below grade.....	0.06
(e)	4" brick, 25/32" rigid insulation, studs, lath and plaster.....	0.21	<b>No. 10. Exposed Walls, Glass Block</b>		
(f)	4" brick, paper, wood sheathing, 3 5/8" rockwool or equivalent, studs, lath and plaster.....	0.08	(a)	3 5/8" Glass Block, corrugated surface.....	0.49
<b>No. 5. Exposed Walls, Hollow Tile</b>			<b>PARTITIONS</b>		
(a)	8" Hollow tile, stucco exterior, furred, lath and plaster.....	0.26	<b>No. 11. Interior Partitions, Frame</b>		
(b)	Same as (5a) substituting 1/2" rigid insulation for lath.....	0.20	(a)	With lath and plaster one side only.....	0.31
<b>No. 6. Exposed Walls, Cinder Block</b>			(b)	Same as (11a) substituting 1/2" rigid insulation for lath.....	0.18
(a)	8" Cinder block, plain.....	0.42	(c)	Same as (11a) with 1/2" rigid insulation on exposed side.....	0.13
(b)	Same as (6a) plastered one side.....	0.39	(d)	With lath and plaster both sides.....	0.17
(c)	Same as (6a) furred, lath and plaster.....	0.27	(e)	Same as (11d) substituting 1/2" rigid insulation for lath.....	0.09
(d)	Same as (6c) substituting 1/2" rigid insulation for lath.....	0.20	(f)	Same as (11d) with 3 5/8" rock wool or equivalent.....	0.04

HEAT LOSS FACTORS

ITEM	DESCRIPTION	FACTOR	ITEM	DESCRIPTION	FACTOR
<b>CEILINGS</b>			<b>WINDOWS AND DOORS</b>		
<b>No. 12. Ceilings with Attic Space Above</b>			<b>No. 18. Windows</b>		
(a)	Lath and plaster, no floor above.....	0.32	(a)	Windows, single (no storm sash).....	1.13
(b)	Lath and plaster, tight floor above.....	0.20	(b)	Window with storm sash, or double glazed....	0.45
(c)	Same as (12a) substituting 1/2" rigid insulation for lath .....	0.23	<b>Doors, Exterior with or without glass</b>		
(d)	Same as (12b) substituting 1/2" rigid insulation for lath .....	0.16	Figure same as windows, No. 18.		
(e)	Same as (12a) with 1/2" rigid insulation on top of joists .....	0.18	<b>INFILTRATION</b>		
(f)	Same as (12a) or (12b) with 3 5/8" rock wool or equivalent .....	0.08	(Based on volume of room in cubic feet)		
<b>No. 13. Ceilings, Part of Shingled Roof— No Attic Space</b>			<b>No. 19. Infiltration, Windows and Doors— Not Weatherstripped</b>		
(a)	Lath and plaster, rafter, sheathing, shingles....	0.29	(a)	Rooms with windows on one side only.....	0.017
(b)	Same as (13a) substituting 1/2" rigid insulation for lath .....	0.21	(b)	Rooms with windows on two sides.....	0.027
(c)	Same as (13a) with 3 5/8" rock wool or equivalent .....	0.08	(c)	Rooms with windows on three sides.....	0.036
<b>No. 14. Ceilings, Part of Built-up Roof— No Attic Space</b>			(d)	Entrance Halls .....	0.036
(a)	Lath and plaster, rafter, sheathing, built-up roofing .....	0.49	(e)	Sun Rooms with many windows on three sides .....	0.054
(b)	Same as (14a) substituting 1/2" rigid insulation for lath .....	0.23	<b>No. 20. Infiltration, Windows and Doors Weatherstripped</b>		
(c)	Same as (14a) with 3 5/8" rock wool or equivalent .....	0.08	(a)	Rooms with windows on one side only.....	0.011
<b>No. 15. Ceilings, Part of Metal Roof—No Attic Space</b>			(b)	Rooms with windows on two sides.....	0.017
(a)	Lath and plaster, joists, sheathing, metal roof	0.26	(c)	Rooms with windows on three sides.....	0.027
(b)	Same as (15a) substituting 1/2" rigid insulation for lath.....	0.18	(d)	Entrance Halls .....	0.027
(c)	Same as (15a) with 3 5/8" rock wool or equivalent .....	0.08	(e)	Sun Rooms with many windows on three sides .....	0.036
<b>FLOORS</b>					
<b>No. 16. Wood Floors, Over-exposed or Unheated Space</b>					
(a)	Double floor on joists.....	0.15			
(b)	Same as (16a) with 1/2" rigid insulation on bottom of joists.....	0.09			
(c)	Same as (16a) with 3 5/8" rock wool or equivalent between joists.....	0.04			
<b>No. 17. Concrete Floors</b>					
(a)	4" thick concrete floor on ground.....	0.06			
(b)	4" thick concrete floor on 3" cinder fill.....	0.06			
(c)	Same as (17b) with hardwood floor on pine sub-floor .....	0.06			
(d)	Concrete floor on ground, below grade.....	0.03			

TABLE 2

SQ. FT. STEAM RADIATION FOR QUANTITIES SHOWN

70 F Indoor—Outdoor Temperature Difference

Square Feet Steam Radiation	GLASS AREA Sq. Ft.		INFILTRATION Room Volume Cu. Ft.					WALL, CEILING AND FLOOR AREAS, SQ. FT.											
	FACTORS		FACTORS					FACTORS											
	0.45	1.13	0.011	0.017	0.027	0.036	0.054	0.03	0.04	0.06	0.08	0.09	0.13	0.15	0.16	0.17	0.18	0.19	0.20
0.5	3.8	1.5	156	101	63.5	47.6	31.7	57.1	42.9	28.6	21.4	19.0	13.2	11.4	10.7	10.1	9.5	9.0	8.6
1.0	7.6	3.0	312	202	127	95.2	63.5	114	85.7	57.1	42.9	38.1	26.4	22.9	21.4	20.2	19.0	18.0	17.1
1.5	11.4	4.6	468	303	190	143	95.2	171	129	85.7	64.3	57.1	39.6	34.3	32.1	30.3	28.6	27.1	25.7
2.0	15.2	6.1	623	403	254	190	127	229	171	114	85.7	76.2	52.7	45.7	42.9	40.3	38.1	36.1	34.3
2.5	19.0	7.6	779	504	317	238	159	286	214	143	107	95.2	65.9	57.1	53.6	50.4	47.6	45.1	42.9
3.0	22.9	9.1	935	605	381	286	190	343	257	171	129	114	79.1	68.6	64.3	60.5	57.1	54.1	51.4
3.5	26.7	10.6	1091	706	444	333	222	400	300	200	150	133	92.3	80.0	75.0	70.6	66.7	63.2	60.0
4.0	30.5	12.1	1247	807	508	381	254	457	343	229	171	152	105	91.4	85.7	80.7	76.2	72.2	68.6
4.5	34.3	13.7	1403	908	571	429	286	514	386	257	193	171	119	103	96.4	90.8	85.7	81.2	77.1
5.0	38.1	15.2	1558	1008	635	476	317	571	429	286	214	190	132	114	107	101	95.2	90.2	85.7
5.5	41.9	16.7	1714	1109	698	524	349	629	471	314	236	210	145	126	118	111	105	99.3	94.3
6.0	45.7	18.2	1870	1210	762	571	381	686	514	343	257	229	158	137	129	121	114	108	103
6.5	49.5	19.7	2026	1311	825	619	413	743	557	371	279	248	171	149	139	131	124	117	111
7.0	53.3	21.2	2182	1412	889	667	444	800	600	400	300	267	185	160	150	141	133	126	120
7.5	57.1	22.8	2338	1513	952	714	476	857	643	429	321	286	198	171	161	151	143	135	129
8.0	61.0	24.3	2493	1613	1016	762	508	914	686	457	343	305	211	183	171	161	152	144	137
8.5	64.8	25.8	2649	1714	1079	810	540	971	729	486	364	324	224	194	182	171	162	153	146
9.0	68.6	27.3	2805	1815	1143	857	571	1029	771	514	386	343	237	206	193	182	171	162	154
9.5	72.4	28.8	2961	1916	1206	905	603	1086	814	543	407	362	251	217	204	192	181	171	163
10.0	76.2	30.3	3117	2017	1270	952	635	1143	857	571	429	381	264	229	214	202	190	180	171
10.5	80.0	31.9	3273	2118	1333	1000	667	1200	900	600	450	400	277	240	225	212	200	189	180
11.0	83.4	33.4	3428	2218	1397	1048	698	1257	943	629	471	419	290	251	236	222	210	199	189
11.5	87.6	34.9	3584	2319	1460	1095	730	1314	986	657	493	438	303	263	246	232	219	208	197
12.0	91.4	36.4	3740	2420	1524	1143	762	1371	1029	686	514	457	316	274	257	242	229	217	206
12.5	95.2	37.9	3896	2521	1587	1190	794	1429	1071	714	536	476	330	286	268	252	238	226	214
13.0	99.0	39.4	4052	2622	1651	1238	825	1485	1114	743	557	495	343	297	279	262	248	235	223
13.5	103	41.0	4208	2723	1714	1286	857	1543	1157	771	579	514	356	309	289	272	257	244	231
14.0	107	42.5	4364	2824	1778	1333	889	1600	1200	800	600	533	369	320	300	282	267	253	240
14.5	110	44.0	4519	2924	1841	1381	921	1657	1243	829	621	552	382	331	311	292	276	262	249
15.0	114	45.5	4675	3025	1905	1429	952	1714	1286	857	643	571	396	343	321	303	286	271	257
15.5	118	47.0	4831	3126	1968	1476	984	1771	1329	886	664	590	409	354	332	313	295	280	266
16.0	121	48.5	4987	3227	2032	1524	1016	1829	1371	914	686	609	422	366	343	323	305	289	274
16.5	126	50.1	5143	3328	2095	1571	1048	1885	1414	943	707	629	435	377	354	333	314	298	283
17.0	130	51.6	5299	3429	2159	1619	1079	1943	1457	971	729	648	448	389	364	343	324	307	291
17.5	133	53.1	5454	3529	2222	1667	1111	2000	1500	1000	750	667	462	400	375	353	333	316	300
18.0	137	54.6	5610	3630	2286	1714	1143	2057	1543	1029	771	686	475	411	386	363	343	325	309
18.5	141	56.1	5766	3731	2349	1762	1175	2114	1586	1057	793	705	488	423	396	373	352	334	317
19.0	145	57.6	5922	3832	2412	1810	1206	2171	1629	1086	814	724	501	434	407	383	362	343	326
19.5	149	59.2	6078	3933	2476	1857	1238	2229	1671	1114	836	743	514	446	418	393	371	352	334
20.0	152	60.7	6234	4034	2540	1905	1270	2285	1714	1143	857	762	527	457	429	403	381	361	343
20.5	156	62.2	6389	4134	2603	1952	1302	2343	1757	1171	879	781	541	469	439	413	390	370	351
21.0	160	63.7	6545	4235	2667	2000	1333	2400	1800	1200	900	800	554	480	450	424	400	379	360
21.5	164	65.2	6701	4336	2730	2048	1365	2457	1843	1229	921	819	567	491	461	434	410	388	369
22.0	168	66.7	6857	4437	2794	2095	1397	2514	1886	1257	943	838	580	503	471	444	419	397	377
22.5	171	68.3	7013	4538	2857	2143	1429	2571	1929	1286	964	857	593	514	482	454	429	406	386
23.0	175	69.8	7169	4639	2921	2190	1460	2629	1971	1314	986	876	607	526	493	464	438	415	394
23.5	179	71.3	7324	4739	2984	2238	1492	2685	2014	1343	1007	895	620	537	504	474	448	424	403
24.0	183	72.8	7480	4840	3048	2286	1524	2743	2057	1371	1029	914	633	549	514	484	457	433	411
24.5	187	74.3	7636	4941	3111	2333	1556	2800	2100	1400	1050	933	646	560	525	494	467	442	420
25.0	190	75.9	7792	5042	3174	2381	1587	2857	2143	1429	1071	952	659	571	536	504	476	451	429

TABLE 2—Continued

SQ. FT. STEAM RADIATION FOR QUANTITIES SHOWN

70 F Indoor—Outdoor Temperature Difference

Square Feet Steam Radiation	WALL, CEILING AND FLOOR AREAS, SQ. FT.																					
	FACTORS																					
	0.21	0.22	0.23	0.24	0.25	0.26	0.27	0.28	0.29	0.30	0.31	0.32	0.33	0.34	0.35	0.37	0.39	0.42	0.46	0.49	0.56	0.69
0.5	8.2	7.8	7.5	7.1	6.9	6.6	6.3	6.1	5.9	5.7	5.5	5.4	5.2	5.0	4.9	4.6	4.4	4.1	3.7	3.5	3.1	2.5
1.0	16.3	15.6	14.9	14.3	13.7	13.2	12.7	12.2	11.8	11.4	11.1	10.7	10.4	10.0	9.8	9.3	8.8	8.2	7.5	7.0	6.1	5.0
1.5	24.5	23.4	22.4	21.4	20.6	19.8	19.0	18.4	17.7	17.1	16.6	16.1	15.6	15.0	14.7	13.9	13.2	12.2	11.2	10.5	9.2	7.5
2.0	32.7	31.2	29.8	28.6	27.4	26.4	25.4	24.5	23.6	22.9	22.1	21.4	20.8	20.0	19.6	18.5	17.6	16.3	14.9	14.0	12.2	9.9
2.5	40.8	39.0	37.3	35.7	34.3	33.0	31.7	30.6	29.6	28.6	27.7	26.8	26.0	25.0	24.5	23.2	22.0	20.4	18.6	17.5	15.3	12.4
3.0	49.0	46.8	44.7	42.9	41.1	39.6	38.1	36.7	35.5	34.3	33.2	32.1	31.2	30.0	29.4	27.8	26.4	24.5	22.4	21.0	18.4	14.9
3.5	57.1	54.5	52.2	50.0	48.0	46.2	44.4	42.9	41.4	40.0	38.7	37.5	36.4	35.0	34.3	32.4	30.8	28.6	26.1	24.5	21.4	17.4
4.0	65.3	62.3	59.6	57.1	54.9	52.7	50.8	49.0	47.3	45.7	44.2	42.9	41.6	40.0	39.2	37.1	35.2	32.8	29.8	28.0	24.5	19.9
4.5	73.5	70.1	67.1	64.3	61.7	59.3	57.1	55.1	53.2	51.4	50.0	48.2	46.8	45.0	44.1	41.7	39.6	36.7	33.5	31.5	27.5	22.4
5.0	81.6	77.9	74.5	71.4	68.6	66.0	63.5	61.2	59.1	57.1	55.3	53.6	52.0	50.0	49.0	46.3	44.0	40.8	37.3	35.0	30.6	24.8
5.5	89.8	85.7	82.0	78.6	75.4	72.5	69.8	67.3	65.0	62.9	60.8	58.9	57.1	55.0	53.9	51.0	48.4	44.9	41.0	38.5	33.7	27.3
6.0	98.0	93.5	89.4	85.7	82.3	79.1	76.2	73.5	70.9	68.6	66.4	64.3	62.3	61.0	58.8	55.6	52.8	49.0	44.8	42.0	36.7	29.8
6.5	106	101	97.0	92.9	89.1	85.7	82.5	79.6	76.8	74.3	71.9	69.6	67.5	66.0	63.7	60.2	57.1	53.1	48.5	45.5	39.8	32.3
7.0	114	109	104	100	96.0	92.3	88.9	85.7	82.8	80.0	77.4	75.0	72.7	71.0	68.6	64.9	61.6	57.1	52.2	49.0	42.9	34.8
7.5	122	117	112	107	103	98.9	95.2	91.8	88.7	85.7	83.0	80.3	77.9	76.0	73.5	69.5	65.9	61.2	55.9	52.5	45.9	37.3
8.0	131	125	119	114	110	105	102	98.8	94.6	91.4	88.5	85.7	83.1	81.0	78.4	74.1	70.3	65.3	59.6	56.0	49.0	39.7
8.5	139	132	127	121	117	112	108	104	100	97.1	94.0	91.1	88.3	86.0	83.3	78.8	74.7	69.4	63.4	59.5	52.0	42.2
9.0	147	140	134	129	123	119	114	110	106	103	99.5	96.4	93.5	91.0	88.2	83.4	79.1	73.5	67.1	63.0	55.1	44.7
9.5	155	148	142	136	130	125	121	116	112	109	105	102	98.7	96.0	93.1	88.0	83.5	77.6	70.8	66.5	58.2	47.2
10.0	163	156	149	143	137	132	127	122	118	114	111	107	104	101	98.0	92.7	87.9	81.6	74.5	70.0	61.2	49.8
10.5	171	164	157	150	144	138	133	129	124	120	116	112	109	106	103	97.3	92.3	85.7	78.3	73.5	64.3	52.1
11.0	180	171	164	157	151	145	140	135	130	126	122	118	114	111	108	102	96.7	89.8	81.9	77.0	67.3	54.6
11.5	188	179	171	164	158	152	146	141	136	131	127	123	119	116	113	107	101	93.9	85.7	80.5	70.4	57.1
12.0	196	187	179	171	165	158	152	147	142	137	133	129	125	121	118	111	106	98.0	89.4	84.0	73.3	59.6
12.5	204	195	186	179	171	165	159	153	148	143	138	134	130	126	122	116	110	102	93.2	87.5	76.5	62.1
13.0	212	203	194	186	178	171	165	159	154	149	144	139	135	131	127	120	114	106	96.9	91.0	79.6	64.6
13.5	220	210	201	193	185	178	171	165	160	154	149	145	140	136	132	125	119	110	101	94.4	82.6	67.1
14.0	229	218	209	200	192	185	178	171	165	160	155	150	145	141	137	130	123	114	104	98.0	85.7	69.6
14.5	237	226	216	207	199	191	184	178	171	166	160	155	151	146	142	134	127	118	108	101	88.8	72.0
15.0	245	234	224	214	206	198	190	184	177	171	166	161	156	151	147	139	132	122	112	105	91.8	74.5
15.5	253	242	231	221	213	204	197	190	183	177	171	166	161	156	152	144	136	127	116	108	94.9	77.0
16.0	261	249	239	229	219	211	203	196	189	183	177	171	166	161	157	148	141	131	119	112	98.0	79.5
16.5	269	257	246	236	226	218	210	202	195	189	182	177	171	166	162	153	145	135	123	115	101	82.0
17.0	278	265	253	243	233	224	216	208	201	194	188	182	177	171	167	158	149	139	127	119	104	84.5
17.5	286	273	261	250	240	231	222	214	207	200	194	187	182	176	171	162	154	143	130	122	107	86.9
18.0	294	281	268	257	247	237	229	220	213	206	199	193	187	182	176	167	158	147	134	126	110	89.4
18.5	302	288	276	264	254	244	235	227	219	211	205	198	192	187	181	171	163	151	138	129	113	91.9
19.0	310	296	283	271	261	251	241	233	225	217	210	204	197	192	186	176	167	155	142	133	116	94.4
19.5	318	304	291	279	267	257	248	239	231	223	216	209	203	197	191	181	171	159	145	136	119	96.9
20.0	327	312	298	286	274	264	254	245	236	229	221	214	208	202	196	185	176	163	149	140	122	99.4
20.5	335	319	306	293	281	270	260	251	242	234	227	220	213	207	201	190	180	167	153	143	126	102
21.0	343	327	313	300	288	277	267	257	248	240	232	225	218	212	206	195	185	171	157	147	129	104
21.5	351	335	320	307	295	284	273	263	254	246	238	230	223	217	211	199	189	176	160	150	132	107
22.0	359	343	328	314	302	290	279	269	260	251	243	236	229	222	216	204	193	180	164	154	135	109
22.5	367	351	335	321	309	297	286	276	266	257	249	241	234	227	220	208	198	184	168	157	138	112
23.0	376	358	343	329	315	303	292	282	272	263	254	246	239	232	225	213	202	188	171	161	141	114
23.5	384	366	350	336	322	310	298	288	278	269	260	252	244	237	230	218	207	192	175	164	144	117
24.0	392	374	358	343	329	316	305	294	284	274	265	257	249	242	235	222	211	196	179	168	147	119
24.5	400	382	365	350	336	323	311	300	290	280	271	262	255	247	240	227	215	200	183	171	150	122
25.0	408	390	373	357	343	330	317	306	296	286	277	268	260	252	245	232	220	204	186	175	153	124

TABLE 3

**EQUIVALENT SQ. FT. OF RADIATION**  
 For Various Indoor-Outdoor Temperature Differences

70 F	50 F	55 F	60 F	65 F	75 F	80 F	85 F	90 F	70 F	50 F	55 F	60 F	65 F	75 F	80 F	85 F	90 F
5.0	3.6	3.9	4.3	4.6	5.3	5.7	6.1	6.4	30.0	21.3	23.7	25.8	27.9	32.1	34.2	36.6	38.7
5.5	3.9	4.3	4.7	5.1	5.9	6.3	6.7	7.1	30.5	21.6	24.1	26.2	28.4	32.6	34.8	37.2	39.3
6.0	4.3	4.7	5.2	5.6	6.4	6.8	7.3	7.7	31.0	22.0	24.5	26.7	28.8	33.2	35.3	37.8	40.0
6.5	4.7	5.1	5.6	6.0	6.9	7.4	7.9	8.5	31.5	22.4	24.9	27.1	29.3	33.7	35.9	38.4	40.6
7.0	5.0	5.5	6.0	6.5	7.5	8.0	8.5	9.0	32.0	22.7	25.2	27.5	29.8	34.2	36.5	39.0	41.3
7.5	5.3	5.9	6.4	7.0	8.0	8.5	9.1	9.7	32.5	23.1	25.7	27.9	30.2	34.8	37.0	39.6	41.9
8.0	5.7	6.3	6.9	7.4	8.6	9.1	9.8	10.3	33.0	23.4	26.1	28.4	30.7	35.3	37.6	40.3	42.6
8.5	6.0	6.7	7.3	7.9	9.1	9.7	10.4	11.0	33.5	23.8	26.5	28.8	31.1	35.8	38.2	40.9	43.2
9.0	6.4	7.1	7.7	8.4	9.6	10.3	11.0	11.6	34.0	24.2	26.9	29.2	31.6	36.4	38.8	41.5	43.9
9.5	6.7	7.5	8.2	8.8	10.2	10.8	11.6	12.2	34.5	24.6	27.2	29.7	32.1	36.9	39.4	42.1	44.4
10.0	7.1	7.9	8.6	9.3	10.7	11.4	12.2	12.9	35.0	25.0	27.5	30.0	32.5	37.5	40.0	42.5	45.0
10.5	7.4	8.3	9.0	9.8	11.2	12.0	12.8	13.5	35.5	25.3	28.0	30.5	33.0	38.0	40.5	43.1	45.8
11.0	7.8	8.7	9.5	10.2	11.8	12.5	13.4	14.2	36.0	25.6	28.4	31.0	33.4	38.5	41.0	43.7	46.4
11.5	8.2	9.0	9.9	10.7	12.3	13.1	14.0	14.8	36.5	25.9	28.8	31.4	33.9	39.0	41.6	44.4	47.1
12.0	8.5	9.5	10.3	11.1	12.8	13.7	14.6	15.4	37.0	26.3	29.2	31.8	34.4	39.6	42.2	45.1	47.7
12.5	8.9	9.9	10.7	11.6	13.3	14.2	15.2	16.1	37.5	26.6	29.6	32.2	34.9	40.1	42.7	45.7	48.4
13.0	9.2	10.3	11.1	12.1	13.9	14.8	15.9	16.8	38.0	27.0	30.0	32.7	35.3	40.7	43.3	46.4	49.0
13.5	9.6	10.7	11.6	12.5	14.4	15.4	16.5	17.4	38.5	27.3	30.4	33.1	35.8	41.2	43.9	47.0	49.7
14.0	10.0	11.0	12.0	13.0	15.0	16.0	17.0	18.0	39.0	27.7	30.8	33.5	36.2	41.7	44.5	47.6	50.3
14.5	10.3	11.4	12.5	13.5	15.5	16.5	17.7	18.7	39.5	28.0	31.2	34.0	36.7	42.3	45.1	48.2	50.9
15.0	10.6	11.8	12.9	13.9	16.0	17.1	18.3	19.3	40.0	28.4	31.6	34.4	37.2	42.8	45.6	48.8	51.6
15.5	11.0	12.2	13.3	14.4	16.6	17.7	18.9	20.0	40.5	28.8	32.0	34.8	37.7	43.3	46.2	49.4	52.2
16.0	11.3	12.6	13.8	14.9	17.1	18.2	19.5	20.6	41.0	29.2	32.4	35.3	38.1	43.9	46.8	50.0	52.9
16.5	11.7	13.0	14.2	15.3	17.6	18.8	20.1	21.2	41.5	29.6	32.7	35.7	38.6	44.4	47.4	50.5	53.5
17.0	12.1	13.4	14.6	15.8	18.2	19.4	20.7	21.9	42.0	30.0	33.0	36.0	39.0	45.0	48.0	51.0	54.0
17.5	12.4	13.8	15.0	16.3	18.7	19.9	21.3	22.6	42.5	30.3	33.5	36.5	39.5	45.5	48.5	51.7	54.7
18.0	12.8	14.2	15.5	16.7	19.3	20.5	22.0	23.2	43.0	30.6	34.0	37.0	40.0	46.0	49.0	52.4	55.4
18.5	13.1	14.6	15.9	17.2	19.8	21.1	22.6	23.9	43.5	30.9	34.4	37.4	40.4	46.5	49.6	53.1	56.1
19.0	13.5	15.0	16.3	17.7	20.3	21.7	23.2	24.5	44.0	31.2	34.8	37.8	40.9	47.1	50.2	53.7	56.8
19.5	13.8	15.4	16.8	18.1	20.9	22.2	23.8	25.1	44.5	31.6	35.1	38.3	41.4	47.6	50.7	54.3	57.4
20.0	14.2	15.8	17.2	18.6	21.4	22.8	24.4	25.8	45.0	31.9	35.5	38.7	41.8	48.1	51.3	54.9	58.0
20.5	14.6	16.2	17.6	19.1	21.9	23.4	25.0	26.4	45.5	32.3	35.9	39.1	42.3	48.7	51.9	55.5	58.7
21.0	15.0	16.5	18.0	19.5	22.5	24.0	25.5	27.0	46.0	32.7	36.3	39.6	42.8	49.2	52.4	56.1	59.3
21.5	15.3	16.9	18.5	20.0	23.0	24.5	26.2	27.7	46.5	33.0	36.7	40.0	43.2	49.8	53.0	56.7	60.0
22.0	15.6	17.3	18.9	20.5	23.5	25.1	26.8	28.4	47.0	33.4	37.1	40.4	43.7	50.3	53.6	57.3	60.6
22.5	16.0	17.7	19.3	20.9	24.1	25.6	27.4	29.0	47.5	33.8	37.5	40.9	44.2	50.8	54.2	58.0	61.3
23.0	16.3	18.1	19.8	21.4	24.6	26.2	28.1	29.7	48.0	34.2	37.9	41.3	44.6	51.4	54.7	58.6	61.9
23.5	16.6	18.5	20.2	21.8	25.1	26.8	28.7	30.3	48.5	34.6	38.2	41.7	45.1	51.9	55.3	59.0	62.6
24.0	17.0	18.9	20.6	22.3	25.7	27.4	29.3	31.0	49.0	35.0	38.5	42.0	45.5	52.5	56.0	59.5	63.0
24.5	17.4	19.3	21.1	22.8	26.2	27.9	29.9	31.6	49.5	35.3	39.0	42.5	46.0	53.0	56.5	60.1	63.7
25.0	17.7	19.7	21.5	23.2	26.7	28.5	30.5	32.2	50.0	35.6	39.5	43.0	46.5	53.5	57.0	60.7	64.4
25.5	18.1	20.1	21.9	23.7	27.3	29.1	31.1	32.9	50.5	35.9	39.9	43.4	47.0	54.0	57.6	61.4	65.1
26.0	18.4	20.5	22.4	24.2	27.8	29.6	31.7	33.5	51.0	36.2	40.3	43.9	47.4	54.6	58.1	62.1	65.8
26.5	18.8	20.9	22.8	24.6	28.3	30.2	32.3	34.2	51.5	36.6	40.7	44.3	47.9	55.1	58.7	62.8	66.4
27.0	19.2	21.3	23.2	25.1	28.9	30.8	32.9	34.8	52.0	36.9	41.1	44.7	48.4	55.6	59.3	63.4	67.1
27.5	19.6	21.7	23.6	25.6	29.4	31.3	33.5	35.5	52.5	37.3	41.5	45.1	48.8	56.2	59.9	64.1	67.7
28.0	20.0	22.0	24.0	26.0	30.0	32.0	34.0	36.0	53.0	37.6	41.9	45.6	49.3	56.7	60.4	64.7	68.4
28.5	20.3	22.5	24.5	26.5	30.5	32.5	34.7	36.7	53.5	38.0	42.3	46.0	49.8	57.2	61.0	65.3	69.0
29.0	20.6	22.9	24.9	27.0	31.0	33.1	35.4	37.4	54.0	38.3	42.7	46.4	50.2	57.8	61.6	65.9	69.7
29.5	20.9	23.3	25.4	27.4	31.6	33.6	36.0	38.0	54.5	38.7	43.1	46.9	50.7	58.3	62.1	66.5	70.3
									55.0	39.1	43.5	47.3	51.2	58.9	62.7	67.1	71.0



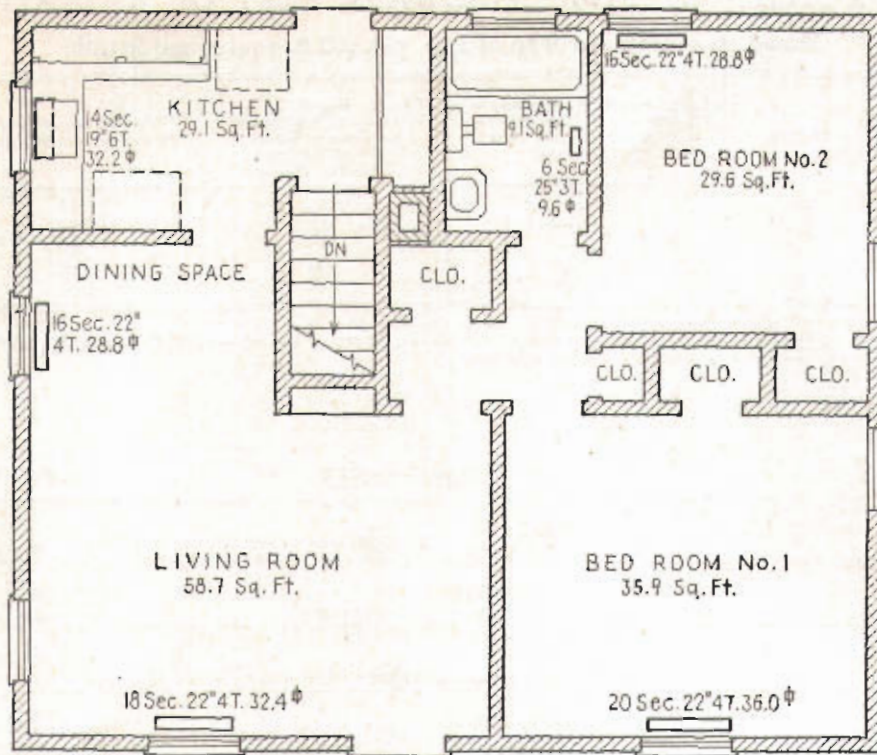

FIRST FLOOR

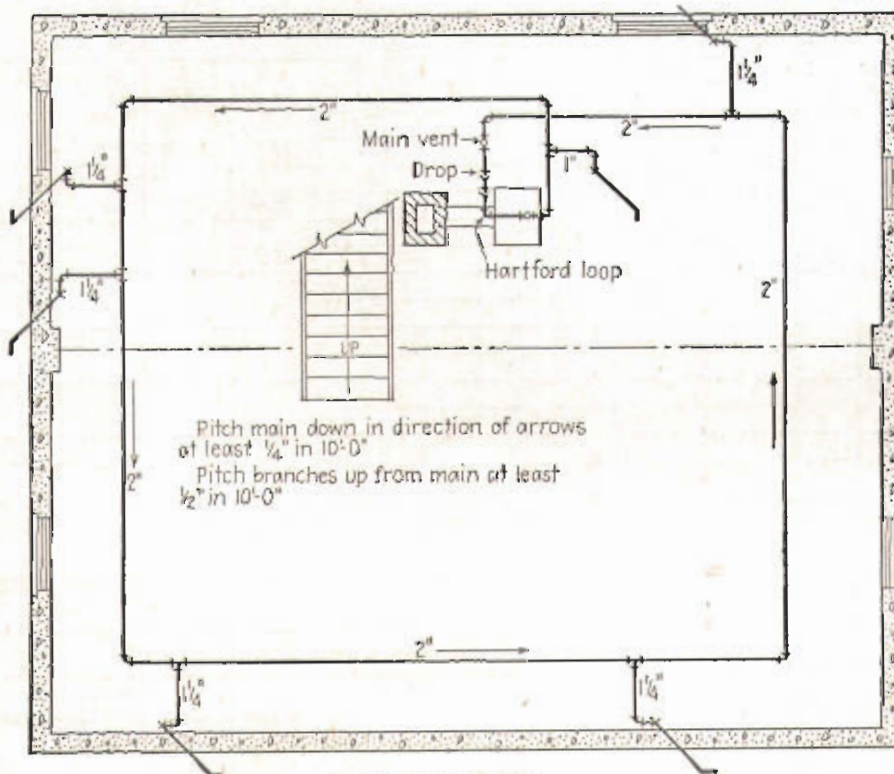

BASEMENT



## SUGGESTED CONTROL ARRANGEMENTS

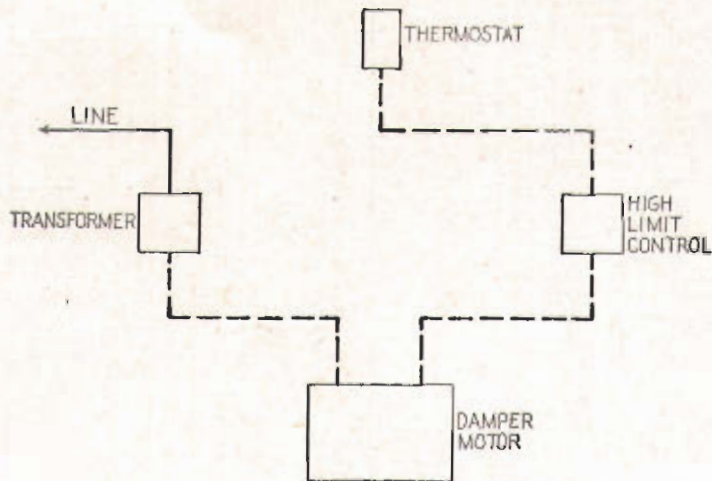

### HAND FIRED—No Domestic Hot Water Supply

1. Check damper and draft damper controlled by thermostat.
2. High steam pressure causes high limit control to close draft damper and open check damper.

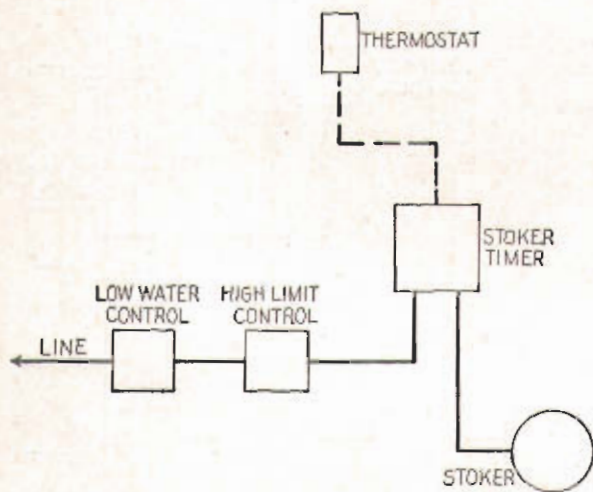

### STOKER FIRED—No Domestic Hot Water Supply

1. Stoker controlled by thermostat.
2. High steam pressure causes high limit control to stop stoker.
3. Stoker timer operates stoker at regular intervals to maintain fire.
4. Low water cutoff stops stoker in event of low water.

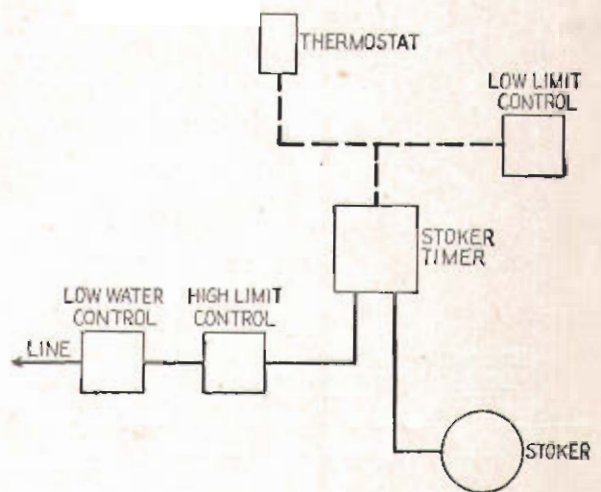

### STOKER FIRED—With Domestic Hot Water Supply

1. Stoker controlled by thermostat.
2. High steam pressure causes high limit control to stop stoker.
3. Stoker timer operates stoker at regular intervals to maintain fire.
4. Low limit control operates stoker to maintain minimum boiler water temperature.
5. Low water cutoff stops stoker in event of low water.

## SUGGESTED CONTROL ARRANGEMENTS

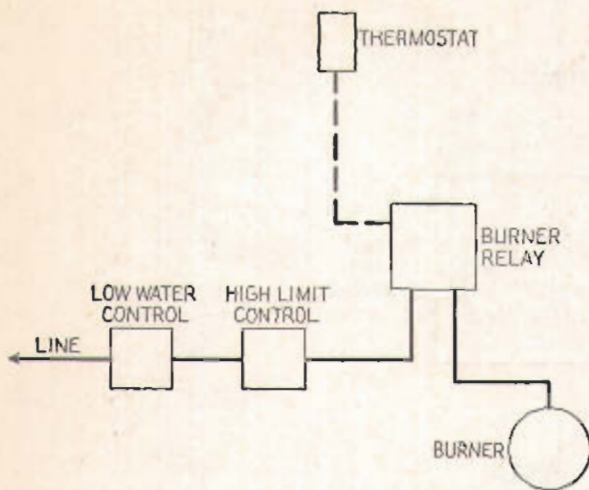

### OIL FIRED--No Domestic Hot Water Supply

1. Burner controlled by thermostat.
2. High steam pressure causes high limit control to stop burner.
3. Low water control stops burner in event of low water.

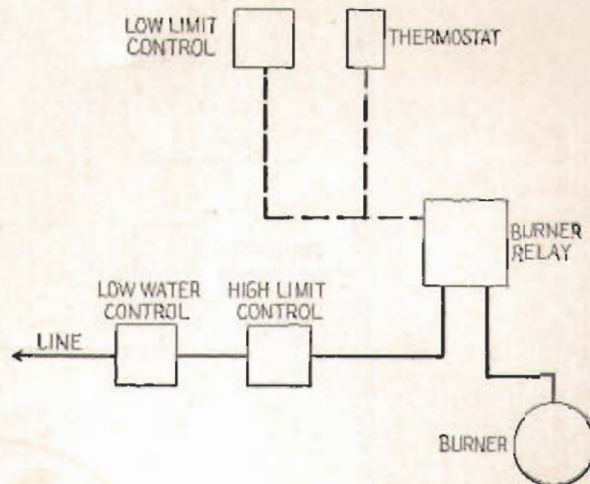

### OIL FIRED--With Domestic Hot Water Supply

1. Burner controlled by thermostat.
2. High steam pressure causes high limit control to stop burner.
3. Low limit control operates burner to maintain minimum boiler water temperature.
4. Low water cutoff stops burner in event of low water.

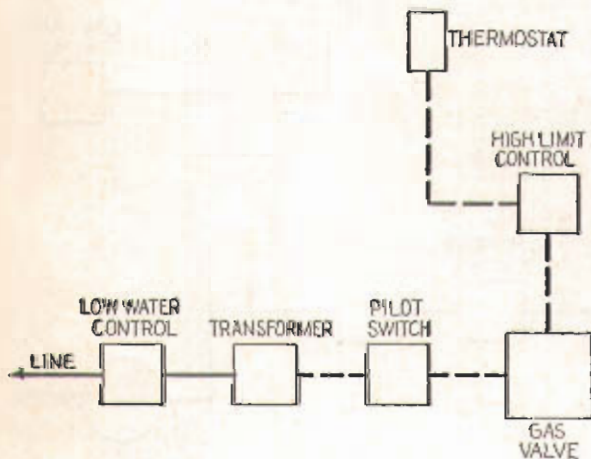

### GAS FIRED--No Domestic Hot Water Supply

1. Burner controlled by thermostat.
2. Should pilot flame be extinguished burner cannot be operated until pilot has been relighted and pilot switch re-set.
3. High steam pressure causes high limit control to stop burner.
4. Low water cutoff stops burner in event of low water.

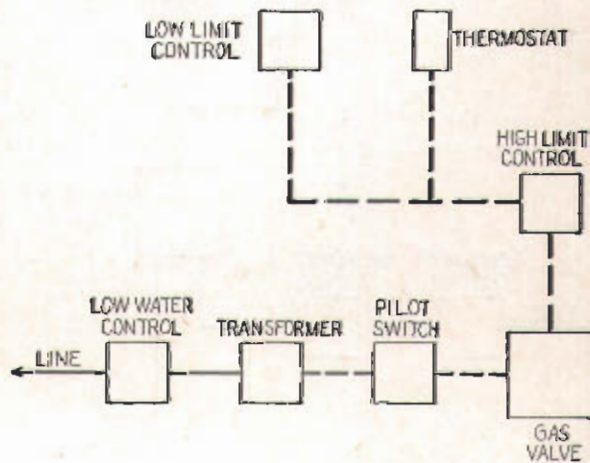

### GAS FIRED--With Domestic Hot Water Supply

1. Burner controlled by thermostat.
2. Should pilot flame be extinguished burner cannot operate until pilot has been relighted and pilot switch re-set.
3. High steam pressure causes high limit control to stop burner.
4. Low limit control operates burner to maintain minimum boiler water temperature.
5. Low water cutoff stops burner in event of low water.



Reg. U. S. Pat. Off.



I-B-R RESEARCH HOME, URBANA, ILLINOIS

For additional information or copies of this Guide, write:

**THE INSTITUTE OF BOILER AND RADIATOR MANUFACTURERS**

60 East 42nd Street

New York 17, N. Y.

or the following manufacturers:

**BURNHAM BOILER CORPORATION**

Irrington, New York

**CRANE CO.**

836 So. Michigan Ave., Chicago 5, Illinois

**DUNKIRK RADIATOR CORPORATION**

Dunkirk, New York

**THE EASTERN FOUNDRY COMPANY**

Boyetown, Pennsylvania

**INTERNATIONAL HEATER COMPANY**

Utica 2, New York

**KOHLER CO.**

Kohler, Wisconsin

**THE NATIONAL RADIATOR COMPANY**

Johnstown, Pennsylvania

**FRANK PROX COMPANY, INC.**

Terre Haute, Indiana

**THE H. B. SMITH COMPANY, INC.**

Westfield, Massachusetts

**SPENCER HEATER DIVISION**

Williamsport 18, Pennsylvania

**THATCHER FURNACE COMPANY**

Garwood, New Jersey

**UNITED STATES RADIATOR CORPORATION**

Detroit 31, Michigan

**UTICA RADIATOR CORPORATION**

Utica 2, New York

**WEIL-McLAIN COMPANY**

Michigan City, Indiana

**ANDERSON PRODUCTS, INC.**

Cambridge, Massachusetts

**AXEMAN-ANDERSON ASSOCIATES**

Williamsport 3, Pennsylvania

**BELL & GOSSETT COMPANY**

Morton Grove, Illinois

**THE DOLE VALVE COMPANY**

Chicago 12, Illinois

**GENERAL FITTINGS COMPANY**

Providence 5, Rhode Island

**HOFFMAN SPECIALTY COMPANY**

Indianapolis 7, Indiana

**JAS. P. MARSH CORPORATION**

Chicago 14, Illinois

**MCDONNELL & MILLER**

Chicago 11, Illinois

**MINNEAPOLIS HONEYWELL REGULATOR CO.**

Minneapolis 8, Minnesota

**MODINE MANUFACTURING COMPANY**

Racine, Wisconsin

**TACO HEATERS, INCORPORATED**

New York 17, New York

**H. A. THRUSH & COMPANY**

Peru, Indiana

**THE TRANE COMPANY**

LaCrosse, Wisconsin